



AlluminioLegno

Sistemi battenti e scorrevoli per infissi in alluminio / legno
Aluminium/Wood Casement and Sliding Systems

Nathura in casa

La tua casa

**Trasforma il tuo abitare: il calore del legno,
la bellezza di infissi che durano nel tempo,
ti offrono un comfort senza precedenti.**

Your home.

Change your living space: the warmth of wood, the beauty of windows that will last, to offer you unbeatable comfort.



AlluminioLegno, l'espressione più naturale di ALsystem. Un'ampia gamma di sistemi da utilizzare per tutte le tipologie di finestre che potete desiderare.

Aluminium Wood, the most natural expression of our systems. An expansive range of solutions used for all window combinations required.

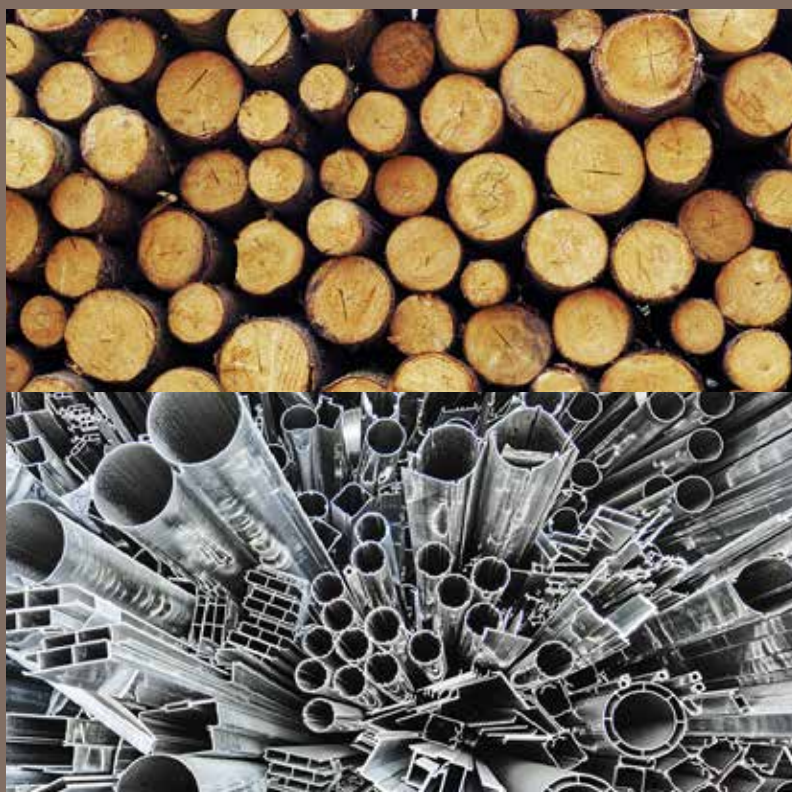

Ogni nostro sistema è testato all'interno di un laboratorio specializzato per assicurare ai clienti la massima qualità e la garanzia delle prestazioni.
Ogni sistema è frutto di ricerca tecnologica, test ambientali, prove empiriche volte alla valorizzazione dell'isolamento termico e acustico.

Our systems are tested in a specialized laboratory to achieve the highest quality standards and provide our customers with a genuine guarantee of performance. Each system is the result of technical research, environmental and empirical testing for the enhancement of thermal and acoustic insulation.

**Tutte le nostre cornici sono in legno massello levigato.
Sono protette con vernici poliuretatiche.
Le essenze standard sono frassino e rovere, ma a richiesta è possibile ottenere svariate alternative.**

All of our wood frames are polished solid wood. They are protected with a polyurethane varnish. The standard essences are ash and oak, but upon request alternatives are available.

AlluminioLegno battente e scorrevole

La gamma dei sistemi ALsystem ti offre
la possibilità di creare il design
e l'architettura che desideri.

*ALUMINUM/WOOD casement | slide
With every system you can create the design and architecture that you want.*

Sistemi: battenti Nathura - scorrevoli Slidewood160, Topslidewood214
Casement Nathura - slide/lift&slide Slidewood160, Topslidewood214

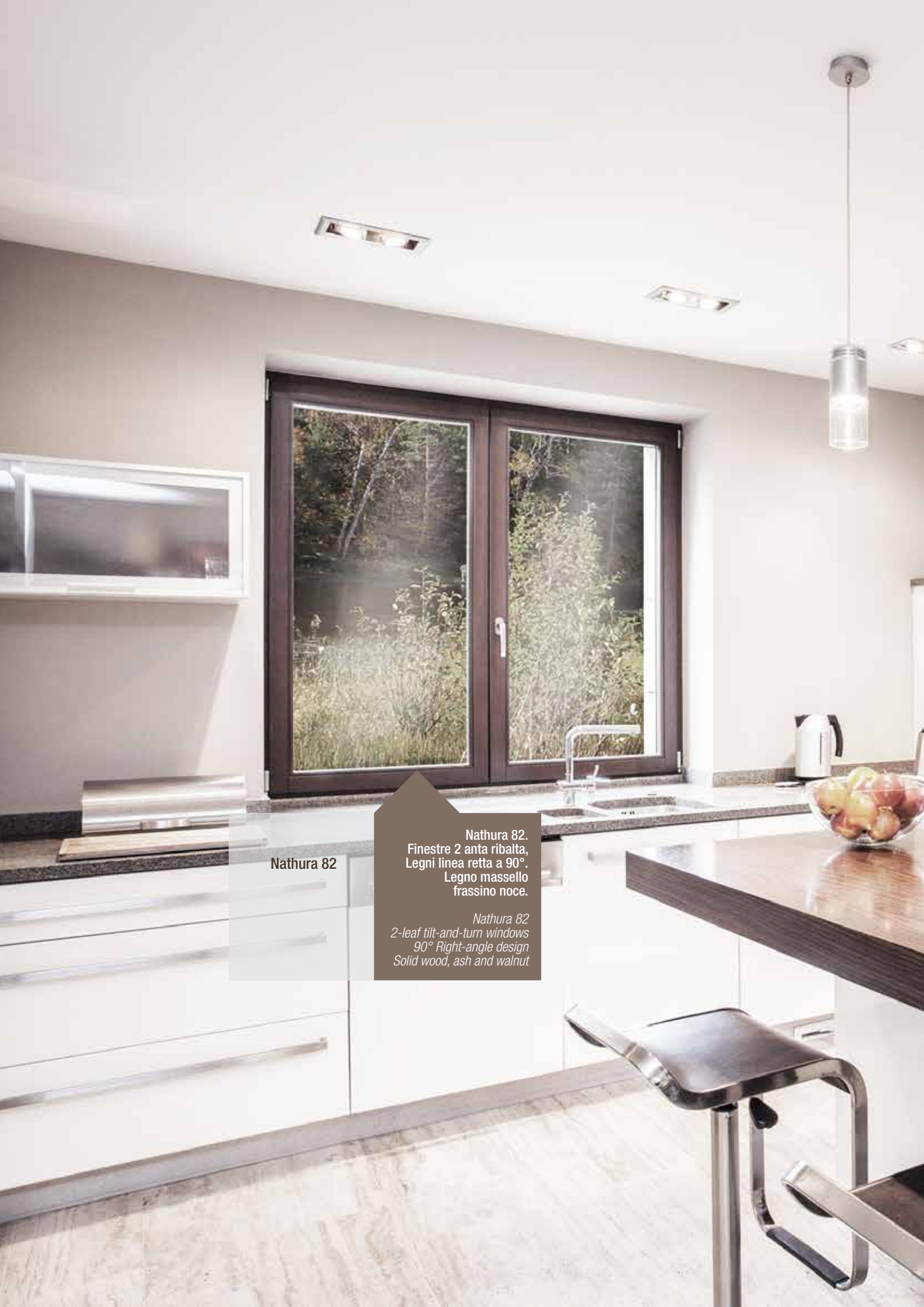

Nathura 82

Nathura 82.
Finestre 2 anta ribalta,
Legni linea retta a 90°.
Legno massello
frassino noce.

*Nathura 82
2-leaf tilt-and-turn windows
90° Right-angle design
Solid wood, ash and walnut*

La serie NATHURA è molto versatile. I prodotti sono ideati per ogni tipo di applicazione. Una soluzione ideale per chi vuole la tradizione del legno, abbinata alla tecnologia e alla bassissima manutenzione dell'alluminio. Nonostante il legno sia un materiale tradizionale, grazie alla varietà del design e delle linee estetiche disponibili, si presta all'applicazione in ogni contesto: dal più classico al più moderno.

Nathura series is very flexible. The products are suitable for every application. An ideal solution for those who want the tradition of wood, combined with the technology and the lack of aluminium maintenance. Although wood is a traditional material, thanks to variety of design and aesthetic available lines, it is suitable for application in any context: from classic to modern.

Nathura
sistema battente
Alluminio/Legno ad alta
efficienza energetica.

Nathura,
casement system.
Aluminium/wood - high
energy-efficiency

alsistem.com

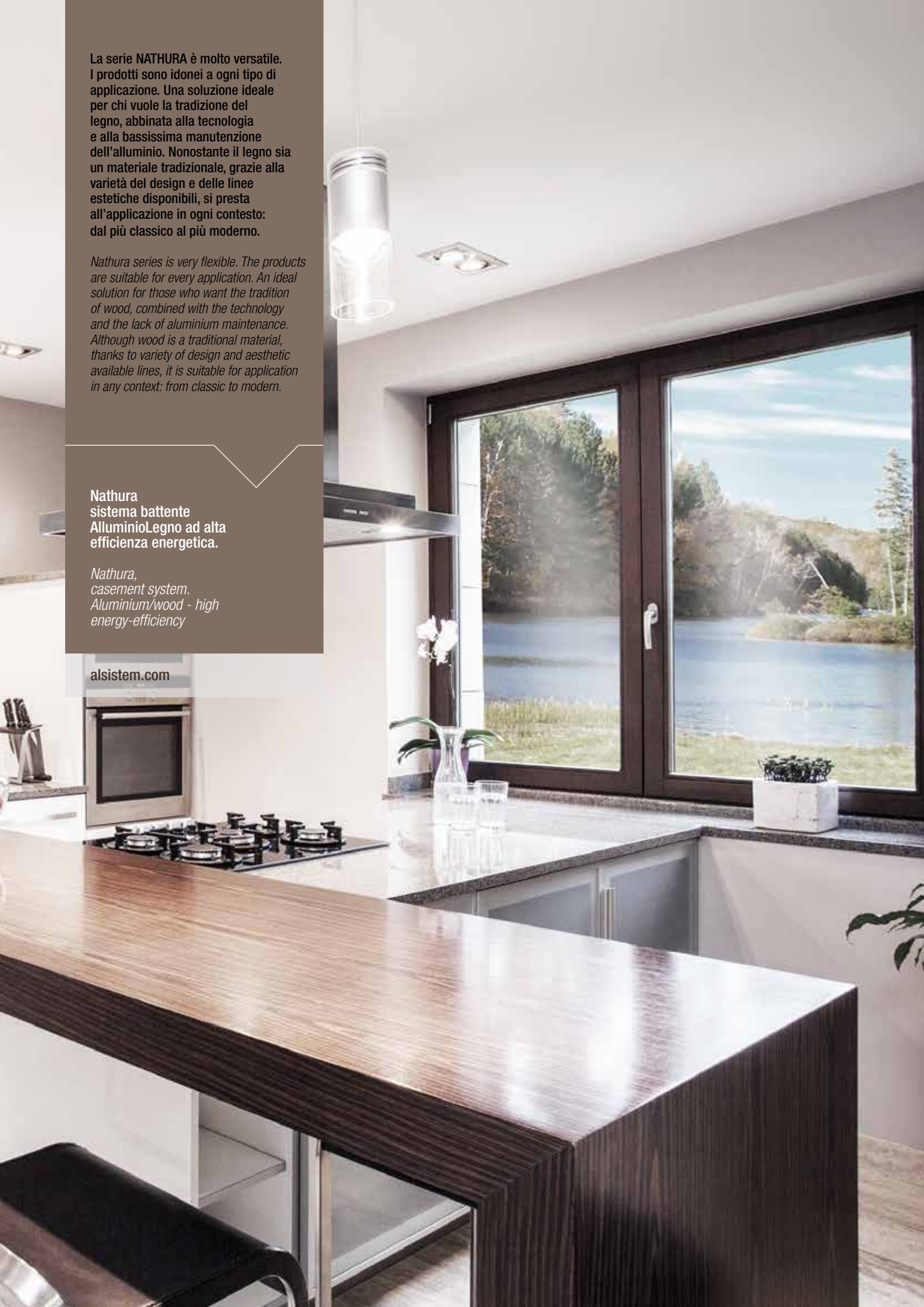



Le serie SLIDEWOOD e TOPSLIDEWOOD sono sistemi che offrono la possibilità di realizzare soluzioni scorrevole e alzante; ideale per grandi e grandissime specchiature. Offrono un'ampia gamma di finiture e soluzioni.

SLIDEWOOD and TOPSLIDEWOOD systems provide slide/lift-and-slide solutions; perfect for large and very large windows. These offer a wide range of different finishings and solutions.

Sistemi alluminio/legno scorrevole e alzante ad alta efficienza energetica.

SLIDEWOOD/TOPSLIDEWOOD slide/lift-and-slide system. Aluminium/wood - high energy-efficiency

alsistem.com



Topslidewood 214

Topslidewood 214.
Porta finestra 2 ante alzanti.
Legni linea retta a 45°.
Frassino tinto bianco con
pori aperti, venatura grigia.

*Topslidewood 214
2-sash lift-and-slide windows
Squared design 45°
White ash, open pore, grey
veining*



**Dettagli che fanno la differenza.
Meccanismo anta ribalta che permette di areare i locali
mantenendo la sicurezza della chiusura.**

*Details that make the difference.
Tilt-and-turn mechanism that allows room ventilation while
maintaining closure security.*

Sistemi senza limiti

Accessori e sistemi di apertura
di alta qualità. Il meglio del mercato
per completare i prodotti più
innovativi del settore

*Opening systems. Limitless systems. High-quality accessories and opening systems.
The best in the market to complete the most innovative products in the field*

Sistema di apertura
Opening systems

**PERCHÉ SOSTITUIRE LE
VECCHIE FINESTRE CON INFISSI IN
ALLUMINIO-LEGNO**

1. Per rendere la casa più efficiente dal punto di vista del risparmio energetico, fondamentale per una corretta economia domestica.
2. Per rendere la casa più protetta dai rumori del traffico cittadino.
3. Per ridurre quasi a zero la manutenzione degli infissi conservando la tradizionalità del legno. Gli infissi in alluminio all'esterno non richiedono nessun intervento se non una semplice pulizia 2 o 3 volte l'anno.

*WHY REPLACE OLD WINDOWS WITH
ALUMINIUM-WOOD WINDOWS*

1. To make the house more efficient in terms of energy saving, necessary for every home.
2. To make the house more acoustically protected from city noise.
3. To reduce window-maintenance, preserving the traditional character of the wood. The aluminium frames do not require outside maintenance except for simple cleaning: two or three times a year.

**Sistemi alluminio/legno
scorrevole e
alzante ad alta efficienza
energetica.**

*Slide/lift-and-slide system.
Aluminium/wood - high energy-
efficiency*

alsistem.com

Topslidewood 214
Nathura 82

**Topslidewood 214. Porta
finestra 2 ante alzanti.**
Legni linea retta a 90°.
Rovere sbiancato

Nathura 82
Infisso fisso
Linea retta a 90°
Rovere sbiancato

Topslidewood 214
2-sash lift-and-slide
windows
90° Right-angle design
White oak

Nathura82
Fixed windows
90° Right-angle design
White oak



**Particolare giunzione 90°
legni linea retta**
Design detail - 90° right-angled joint
Nathura 82 casement





Cura dei particolari
Attention to detail

**Tutti gli accessori sono in materiali trattati per resistere
alla corrosione e agli agenti atmosferici.**
*All accessories are made with treated materials to resist
corrosion and weathering.*

Soglie che fanno la differenza

**Discrete, funzionali e facili da installare.
Anche le grandi vetrate scivolano leggere
con un semplice tocco.**

*Thresholds that make the difference.
Subtle, functional, and easy to install. Even large windows slide at a simple touch.*

Soglie
Thresholds

I sistemi Slidewood e Topslidewood offrono la possibilità di avere la soglia a filo pavimento, mantenendo inalterate le prestazioni termiche, acustiche e ermetiche.

Slidewood and Topslidewood systems allow having a flush floor-threshold, maintaining high thermal, acoustic, and hermetic performances.

Soglie per sistemi scorrevoli.

Thresholds for slide systems.

alsistem.com



SLIDEWOOD 160
soglia filo pavimento con
ante chiusura 90°
senza montante fisso.
(Il profilo in legno nella foto
è stato realizzato ad hoc)

3 vie.
legno retto anta
vetroinfilare, rovere.

Slidewood 160

Slidewood 160
SLIDEWOOD 160
Flush floor threshold
90° Right-angled joint,
without fixed mullion.
(the wood profile in the
picture was made in situ)

3-rail bead-less type
white oak

SOGLIA STANDARD / STANDARD SILL

Soglia tipica delle finestre a parapetto di altezza 50 mm. Mantiene la cornice costante su tutto il perimetro dell'infisso, anche nella vista esterna.

Typical seal, height 50mm

It maintains the frame constant around the entire perimeter of the window, even on the outside.



SOGLIA RIBASSATA / LOW THRESHOLD

Soglia che abbatte le barriere architettoniche rispettando la misura di norma. Mantiene inalterati i valori di ermeticità dell'infisso. Usata in genere nelle porte balcone di accesso a spazi esterni.

Threshold that removes architectural barriers while respecting the normal measurements. Keeping the tightness of the frame unchanged. This is typically used for balcony doors for outdoor access.



SOGLIA CALPESTABILE / FLOOR THRESHOLD

Tipicamente usata per portoncini. Ideale per ambienti commerciali o pubblici.

*It is normally used with outside doors.
It is ideal for commercial and public use.*

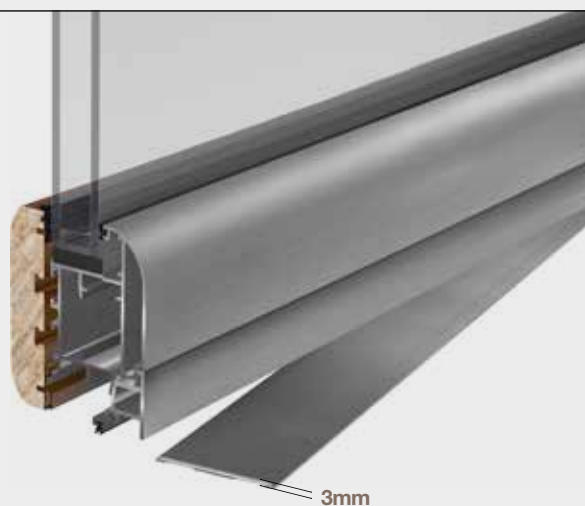

SOGLIA STANDARD / STANDARD THRESHOLD

Soglia con altezza 25mm. a norma per l'abbattimento delle barriere architettoniche. binario in acciaio inox.

*Threshold height 25mm
Compliant with regulation standards to remove the architectural barriers.
Stainless steel rail.*

25mm



TOPSLIDEWOOD 214

SOGLIA CALPESTABILE / FLOOR THRESHOLD

Soglia ribassata altezza 15mm con binario in acciaio inox che funge anche da coprivite*.

Low threshold height 15mm with stainless steel rail that also work as screw-cover.*

15mm



TOPSLIDEWOOD 214

SOGLIA STANDARD / STANDARD THRESHOLD

Soglia con altezza 47mm. binario in acciaio inox. Ideale per la soluzione scorrevole a davanzale.

*Standard Threshold height 47mm.
Stainless steel rail.
Ideal for sliding sill solution.*

47mm



SLIDEWOOD 160

SOGLIA CALPESTABILE / FLOOR THRESHOLD

Soglia ribassata altezza 15mm con binario in acciaio inox che funge anche da coprivite*.

Low threshold height 15mm with stainless steel rail that doubles as a screw cover.*

15mm



SLIDEWOOD 160



Sicurezza

Punti di chiusura anti effrazione. La forma a fungo garantisce una sicurezza maggiore di quelli tradizionali. Si possono avere fino a 12 punti di chiusura in una finestra, raggiungendo la classe 2 di anti effrazione.

Security

Locking anti-burglary point. The mushroom shape provides greater security than conventional locks. Up to 12 closing points per window are available, arriving at the level of Anti-burglary 2nd Class.

Performance e qualità

Tutti i sistemi ALsystem sono certificati da un ente notificato. Raggiungono valori di eccellenza per performance termiche e acustiche.

Performance and quality

All solutions are certified by a notified company. These achieve excellent thermal and acoustic performance.

Sicurezza
Security

**PERCHÉ SOSTITUIRE LE
VECCHIE FINESTRE CON INFISSI IN
ALLUMINIO-LEGNO**

4. Per aumentare la sicurezza della casa. Gli infissi in alluminio sono più sicuri e alcune serie possono offrire un grado di antieffrazione in classe 2
5. Per migliorare l'estetica della casa. Gli infissi in alluminio hanno un design che si adatta al gusto di ogni cliente e ad ogni stile architettonico, perché possono essere rifiniti in ogni colore possibile
6. Perché grazie agli incentivi ed al risparmio immediato sulle bollette, con il recupero fiscale in pochi anni si ammortizza l'investimento e poi si risparmia per sempre.

**WHY REPLACE OLD WINDOWS WITH
ALUMINIUM-WOOD WINDOWS**

4. To increase house security. Aluminium windows are safer and some series can offer Anti-burglary 2nd Class
5. To improve the design. Aluminium windows design suits the tastes of each client and every architectural style, because it can be finished in every possible colour.
6. Because of the incentives, and the immediate cost-savings with tax-recovery, the investment will pay for itself within a few years, and then savings will last forever.

**Sistemi alluminio/legno
scorrevole e alzante ad alta
efficienza energetica.**

*Aluminium/wood slide/lift-and-
slide system in high energy
efficiency*

alsistem.com



**Topslidewood 214
Nathura 82**

**Topslidewood 214.
Porta finestra 2 ante alzanti.
Legni linea retta a 90°.
Rovere laccato bianco.**

*Topslidewood 214
2-sash lift-and-slide window.
90° Right-angle design
White oak.*



Sistema aperture

La finestra offre la possibilità di avere 3 posizioni di apertura:

- microventilazione
- anta ribalta
- anta a battente

Opening systems

Windows have three possible opening-positions

- *Micro-ventilation*
- *Tilt-and-turn*
- *Casement*

Ogni casa ha il suo sistema ideale

Scegli tra le soluzioni Nathura, Slidewood
e Topslidewood. L'alluminio legno
è la combinazione migliore per esaltare
il design e il comfort.

*Each home has its own perfect system
Choose between Nathura/Slidewood - Topslidewood solutions.
Aluminium/wood system is the best combination to improve design and comfort.*

Sistemi, nodi ed essenze
Systems, sections and wood



■ NATHURA 92

Serie con profili a taglio termico al top della gamma con eccellenti prestazioni ambientali, termiche e acustiche. Ideale per grandi specchiature.

- Serie battente alluminio-legno a taglio termico marcata CE
- Sezione telaio 92 mm
- Sezione anta 112 mm
- Sistema di tenuta giunto aperto o doppio battente a seconda delle soluzioni
- Sistema di isolamento termico con barrette da 38 mm
- Ferramenta a nastro certificata fino a 130 kg di portata
- Eccellente isolamento acustico - spazio vetro max. utilizzabile: 80.5mm

■ NATHURA 92

Top thermal-break aluminium wood series, with high environmental and thermal performance

- Alu-wood thermal-break casement CE marked
- Frame section 92mm
- Leaf section from 112mm
- Architectural show lateral section 97 mm
- Architectural show central section 152 mm
- Sealing system open-joint or double-swing depending on the solutions
- Thermal insulation system with 38mm double tubular bars
- Certified hardware up to 130 kg capacity
- High acoustic insulation

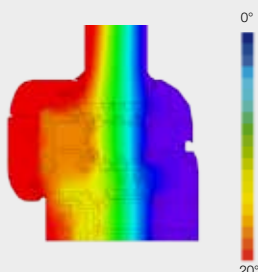
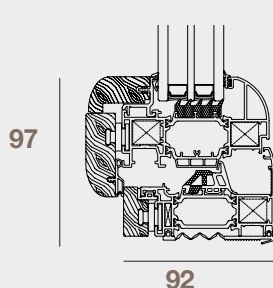

Isolamento termico | Thermal insulation

Uf 1.59 w/m²K

Ug 0.6 w/m²K

Uw 1.0 w/m²K

1 anta
1 anta

Uf 1.59 w/m²K

Ug 0.6 w/m²K

Uw 1.1 w/m²K

2 ante
2 ante

Valori ottenuti su una finestra 1230 x 1480 mm
Tutti i valori riportati sono certificati da ente notificato
All values are obtained on 1230x1480 testing-window.
They are certified by notified company

Permeabilità all'aria
Air-tight

Classe 4

Tenuta all'acqua
Water-tight

Classe E1500

Resistenza al vento
Resistance to wind load

Classe C5



■ NATHURA 82

Serie con profili a taglio termico dalle altissime prestazioni ambientali e termiche.

- Serie battente alluminio-legno a taglio termico marcata CE
- Sezione telaio 82 mm
- Sezione anta 102 mm
- Sistema di tenuta giunto aperto o doppio battente a seconda delle soluzioni
- Sistema di isolamento termico con barrette a doppio tubolare da 28mm
- Ferramenta a nastro certificata fino a 130 kg di portata
- Ottimo isolamento acustico - spazio vetro max. utilizzabile: 70.5mm

■ NATHURA 82

Thermal break aluminium wood series with excellent environmental, thermal and acoustic performance. Ideal for large windows

- Alu-wood thermal break casement CE marked
- Frame section 82 mm
- Leaf section from 102 mm
- Architectural show lateral section 97 mm
- Architectural show central section 152 mm
- Sealing system open-joint or double-swing depending on the solutions
- Thermal-insulation system with bars 38mm
- Certified hardware up to 130 kg capacity
- High acoustic insulation

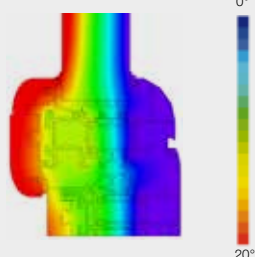
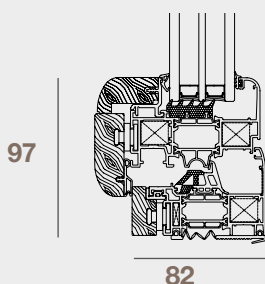

Isolamento termico | Thermal insulation

Uf 1.79 w/m²K

Ug 0.6 w/m²K

Uw 1.0 w/m²K

1 anta
1 anta

Uf 1.79 w/m²K

Ug 0.6 w/m²K

Uw 1.2 w/m²K

2 ante
2 ante

Valori ottenuti su una finestra 1230 x 1480 mm
Tutti i valori riportati sono certificati da ente notificato
All values are obtained on 1230x1480 testing-window.
They are certified by notified company

Permeabilità all'aria
Air-tight

Classe 4

Tenuta all'acqua
Water-tight

Classe E1500

Resistenza al vento
Resistance to wind load

Classe C5



■ NATHURA 70

Serie con profili a taglio termico con ottime prestazioni ambientali e termiche per ogni tipo di infisso.

- Serie battente alluminio-legno a taglio termico marcata CE
- Sezione telaio 70 mm
- Sezione anta 90 mm
- Sistema di tenuta giunto aperto o doppio battente a seconda delle soluzioni
- Sistema di isolamento termico con barrette tubolari da 16mm
- Ferramenta a nastro certificata fino a 130 kg di portata

■ NATHURA 70

Thermal break aluminium/wood series with excellent environmental, thermal and acoustic performance

- Alu-wood thermal break casement CE marked
- Frame section 70 mm
- Leaf section from 90 mm
- Architectural show lateral section 97 mm
- Architectural show central section 152mm
- Sealing system open-joint or double-swing depending on the solutions
- Thermal insulation system with 16mm tubular bars
- Certified hardware up to 130 kg capacity
- High acoustic insulation

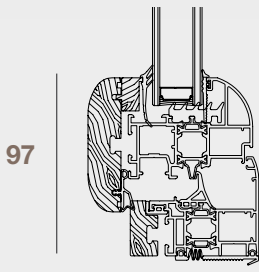

70

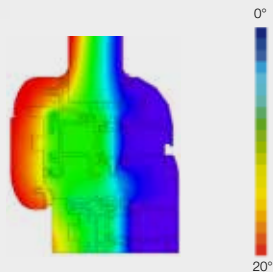

0° Isolamento termico | Thermal insulation

Uf 2.20 W/m²K

Ug 0.6 W/m²K

Uw 1.1 W/m²K

1 anta
1 ante

Uf 2.20 W/m²K

Ug 0.6 W/m²K

Uw 1.4 W/m²K

2 ante
2 ante

Valori ottenuti su una finestra 1230 x 1480 mm
Tutti i valori riportati sono certificati da ente notificato
All values are obtained on 1230x1480 testing-window.
They are certified by notified company

Permeabilità all'aria
Air-tight

Classe 4

Tenuta all'acqua
Water-tight

Classe E1500

Resistenza al vento
Resistance to wind load

Classe C5



■ NATHURA 59

Serie non isolata ma con prestazioni ambientali e termiche che soddisfano molte zone climatiche italiane.

- Sezione telaio 59 mm
- Sezione anta 79 mm
- Nodo laterale 97 mm
- Nodo centrale 152 mm
- Sistema di tenuta giunto aperto
- Ferramenta a nastro certificata fino a 130 kg di portata

■ NATHURA 59

Non-insulated system with environmental and thermal performance that satisfy many Italian climate zones.

- Frame section 59 mm
- Leaf section from 79 mm
- Node side window section 97 mm
- Node central window section 152 mm
- Open-joint sealing system
- Certified hardware up to 130 kg capacity

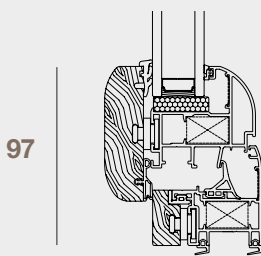

59

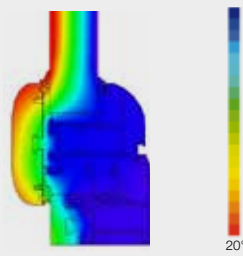

0° Isolamento termico | Thermal insulation

Uf 3.07 W/m²K

Ug 0.9 W/m²K

Uw 1.6 W/m²K

1 anta
1 ante

Uf 3.07 W/m²K

Ug 0.9 W/m²K

Uw 1.8 W/m²K

2 ante
2 ante

Valori ottenuti su una finestra 1230 x 1480 mm
Tutti i valori riportati sono certificati da ente notificato
All values are obtained on 1230x1480 testing-window.
They are certified by notified company

Permeabilità all'aria
Air-tight

Classe 4

Tenuta all'acqua
Water-tight

Classe E1200

Resistenza al vento
Resistance to wind load

Classe C5



TOPSLIDEWOOD 214

Sistema a taglio termico per serramenti alzanti a scorrere di grandi e grandissime dimensioni e peso. Offre eccellenti prestazioni di isolamento termico, acustico e tenuta aria, acqua, vento.

- Sezione telaio 214 mm
- Sezione anta 99 mm
- Serie scorrevole/alzante alluminio-legno a taglio termico marcata CE
- Sistema di tenuta con guarnizioni in materiale espanso rivestito
- Sistema di isolamento termico con barrette complanari doppio tubolare da 28mm
- Ferramenta con portata 300 e 400 kg

TOPSLIDEWOOD 214

Thermal-break system for large and very large lift-and-slide systems. This provides excellent acoustic and thermal insulation, as well as good air, water, and wind sealing

- Frame section 214 mm
- Sash section 99 mm
- Architectural show lateral section 133 mm
- Architectural show lower section 118 mm
- Architectural show higher section 142 mm
- Architectural show central section 113 mm
- Foam-coated Thermal system
- Thermal insulation system with 28mm coplanar double tubular bars
- Hardware up to 300 and 400 kg capacity

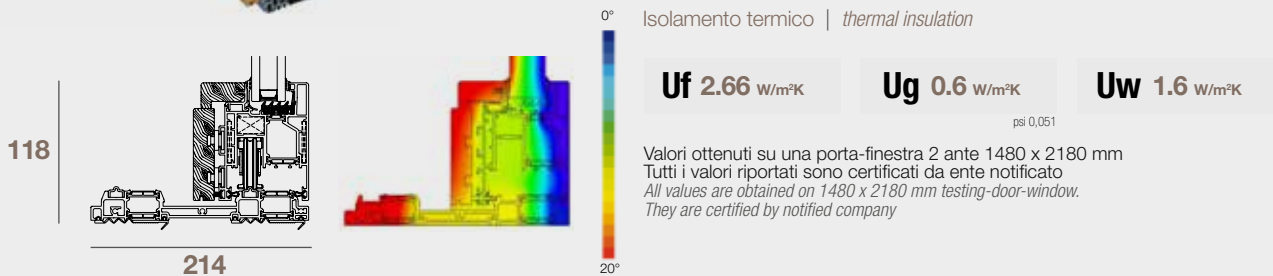

Classe 4



Classe E1500



Classe C4



SLIDEWOOD 160

Sistema a taglio termico scorrevole e alzante con elevate prestazioni termiche.

- Serie scorrevole e alzante alluminio-legno a taglio termico marcata CE
- Sezione telaio 160 mm
- Sezione anta 67 mm
- Sistema con spazzolino per versione scorrevole; con guarnizioni a palloncino in materiale espanso rivestito per alzante
- Sistema di isolamento termico con barrette complanari sulle ante e complanari-tubolari sui telai
- Ferramenta sia scorrevole che alzante con portata fino a 200 kg

SLIDEWOOD 160

Thermal break slide/lift-and-slide system with high thermal performance.

- Alu-wood slide-and-lift and slide series
- Frame section 160 mm
- Sash section 67 mm
- Architectural show lateral section 116 mm
- Architectural show central section 90 mm
- System with brushes for slide version, gaskets for lift-and-slide version
- Thermal insulation system with coplanar bars on sashes and coplanar/tubular on frames
- Slide-and-lift and slide hardware up to 20kg capacity

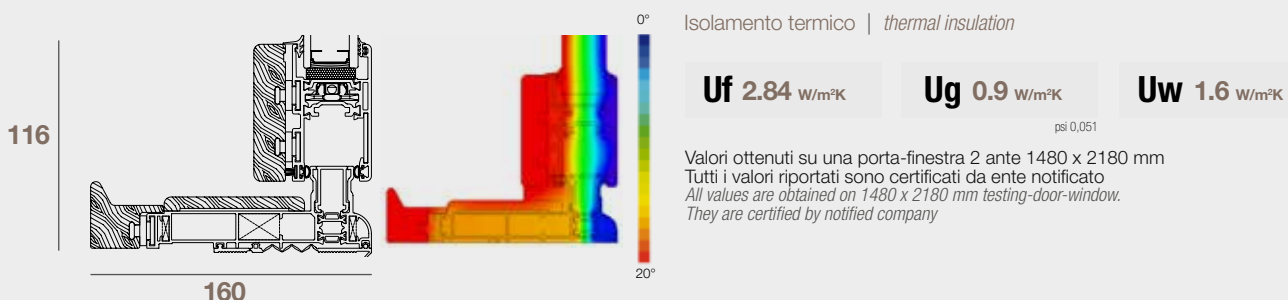

Classe 4



Classe E1500



Classe C4

Linee estetiche
battenti-interno

*Aesthetic Series
Inner casement*



Linea curva - giunto a 45°
Curved design - 45° joint bead-less type



Linea retta - giunto a 90°
Right-angled design - 90° joint bead-less type



Linea retta - giunto a 45°
Squared design - 45° joint bead-less type



Linea retta - giunto a 90° con fermavetro
Squared design - 90° joint with glazing bead



Linea retta - giunto a 45° con fermavetro
Squared design - 45° joint with glazing bead



Linea curva - giunto a 45° con fermavetro
Curved design - 45° joint with glazing bead

Linee estetiche
battenti-esterno

*Design
Casement-outdoor*



Bombato
Curved



Retto
Squared



Raggiato
Rayed



Universalità

**Compatibile con tutte le martelline presenti sul mercato.
Disponibili in varie forme, colori e materiali.**

Universality

*Compatible with all handles on the market.
available in various shapes, colours, and materials.*

Tipologie, forme, design e desideri

Ogni finestra ha la sua forma,
il suo ambiente. ALSistem ha creato
sistemi versatili in grado di soddisfare ogni
esigenza costruttiva.

*Types, shapes, designs, and desires. Each window has its own form and its environment.
All our versatile systems are created to meet every construction need.*

Tipologie disponibili
Available types

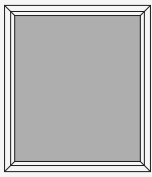

fisso
fixed

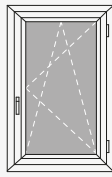

finestra 1
anta ribalta
1-tilt and turn
leaf

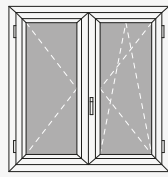

finestra 2 ante
ribalta
2-tilt and turn
leaf

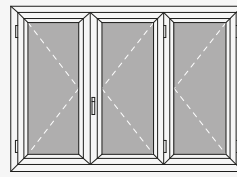

finestra 3 ante
3-leaf window

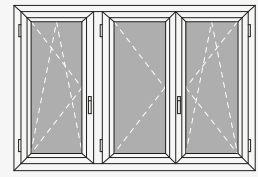

finestra abbinata 1 anta + 2 ante
matched window 1-leaf + 2-leaf

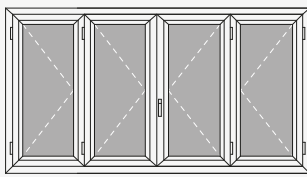

finestra 4 ante
4-leaf window

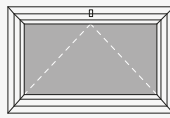

vasistas
transom window

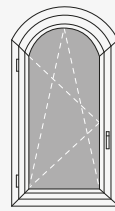

finestra centinata
1 anta ribalta
bowed window
1-tilt and turn leaf

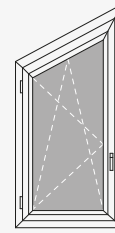

finestra trapezio 1
anta ribalta
1-leaf trapeze window

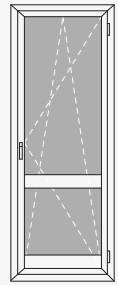

porta finestra
1 anta ribalta
balcony door
1-tilt and turn leaf

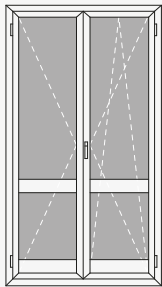

porta finestra
2 ante ribalta
balcony door
2-leaf tilt and turn

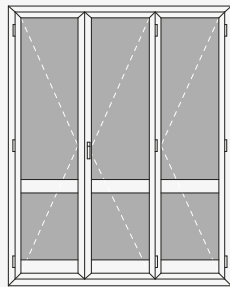

porta finestra 3 ante
3-leaf balcony door

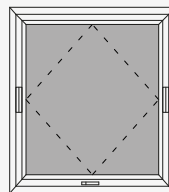

bilico orizzontale
horizontal pivot window

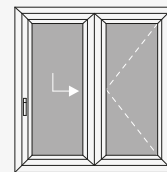

scorrevole parallelo
+ apribile
tilt&slide + opening

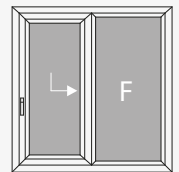

scorrevole
parallelo + fisso
tilt&slide + fixed

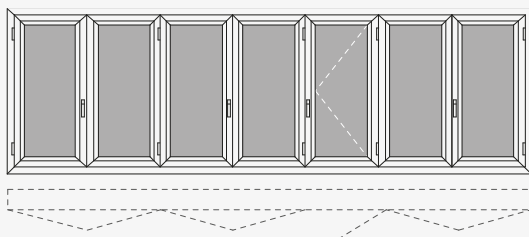

finestra 7 ante scorrevoli a libro (4+3)
7 panel folding window (4+3)

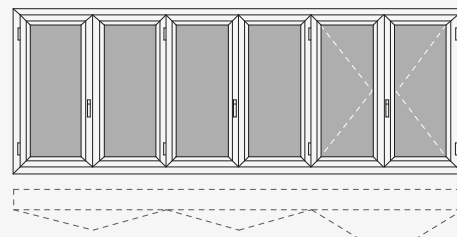

finestra 6 ante scorrevoli a libro (5+1)
6 panel folding window (5+1)

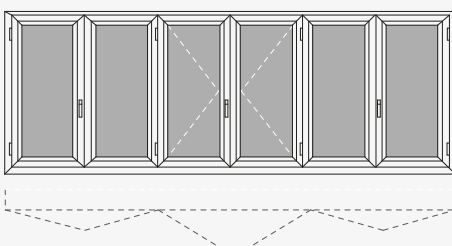

finestra 6 ante scorrevoli a libro (3+3)
6 panel folding window (3+3)

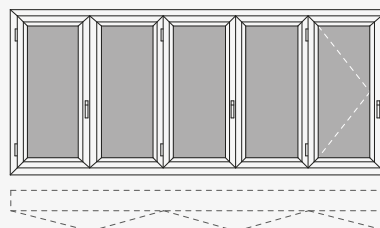

finestra 5 ante scorrevoli a libro (5)
5 panel folding window (5)

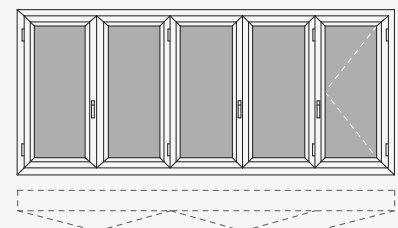

finestra 5 ante scorrevoli a libro (4+1)
5 panel folding window (4+1)

Tipologie scorrevoli
Slide type

Tipologie alzanti
Lift&slide type

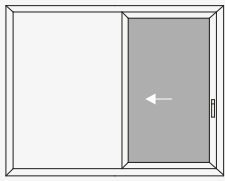

monovia
1 rail

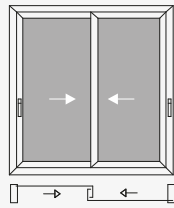

2 vie - 2 ante
2 rail-2 sash

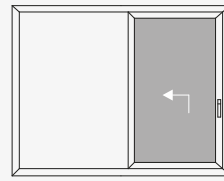

monovia
1 rail

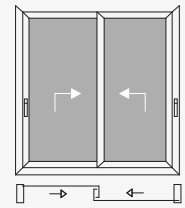

2 vie - 2 ante
2 rail-2 sash

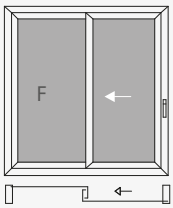

2 vie - 1 anta+fisso
2 rail-1 sash+fixed

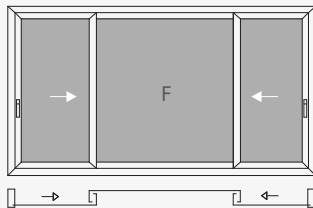

2 vie - 2 ante+fisso
2 rail-2 sash+fixed

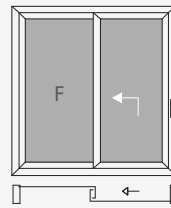

2 vie - 1 anta+fisso
2 rail-1 sash+fixed

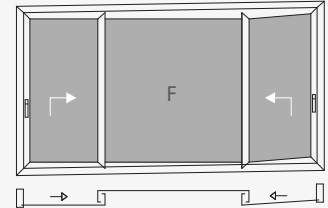

2 vie - 2 ante+fisso
2 rail-2 sash+fixed

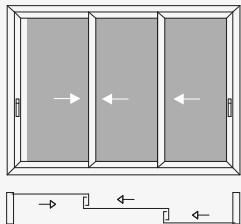

3 vie - 3 ante
3 rail-3 sash

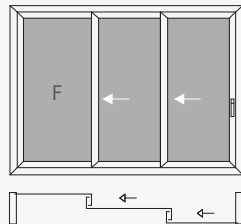

3 vie - 2 ante+fisso
3 rail-2 sash+fixed

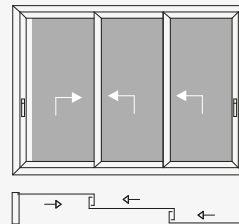

3 vie - 3 ante
3 rail-3 sash

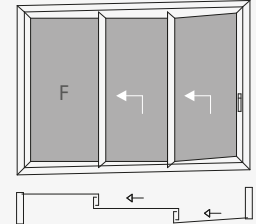

3 vie - 2 ante+fisso
3 rail-2 sash+fixed

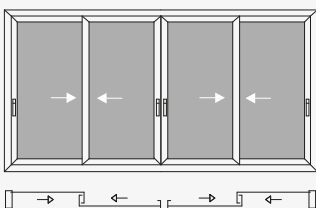

2 vie - 4 ante
2 rail-4 sash

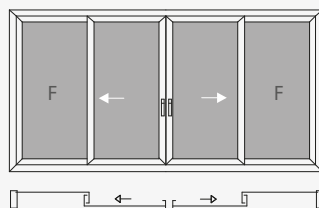

2 vie - 2 ante+2 fissi
2 rail-2 sash+2 fixed

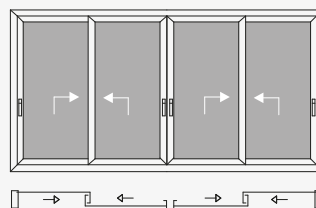

2 vie - 4 ante
2 rail-4 sash

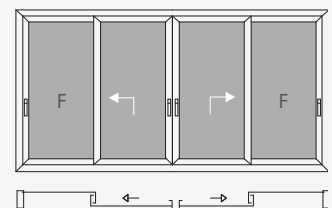

2 vie - 2 ante+2 fissi
2 rail-2 sash+2fixed

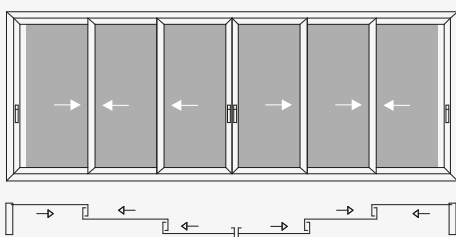

3 vie - 6 ante
3 rail-6 sash

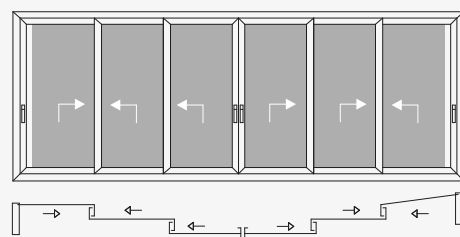

3 vie - 6 ante
3 rail-6 sash



Finestre Nathura 70
1 anta ribalta + fisso.
Legni linea curva a 45°.
Legno massello
frassino noce.

*Nathura 70
1-leaf tilt&turn + fixed
Curved design 45°
Solid wood, ash-walnut.*



Particolare legni-linea curva
battente Nathura 70
*Design detail-curved joint
Nathura casement*

Nathura 70

ALsistem offre una gamma di essenze base in frassino o rovere, con la possibilità di essere tinte in tutte le tonalità richieste e con diverse finiture, per valorizzare la naturale bellezza del legno:

- laccato
- opaco
- lucido
- decapato
- a pori chiusi
- a pori aperti
- impiallacciato - radica, oro, argento

A wide range of ash and oak wood, finished in all requested tones, to enhance the natural beauty of the wood:

- lacquered
- matt
- polished
- pickled
- closed pore
- open pore
- veneer
- briar, gold, silver

La versatilità dell'alluminio ci consente di offrire finiture esterne anodizzate di ogni tipo:

- lucido
- satinato
- anodizzato colorato
- tipo acciaio

Per adattarsi ad ogni tipo di edificio. L'alluminio può essere verniciato in ogni tonalità e colore:

- RAL (finiture pastello)
- mazzati (finiture puntinate)

Per chi ha gusti particolari o per adattarsi allo stile architettonico esterno, l'alluminio può essere verniciato (sblimato) in varie soluzioni di design:

- effetto marmo
- effetto legno
- effetto rame
- effetto ruggine (corten)

Aluminium versatility provides anodized exterior finishes:

- polished
- satin
- coloured anodized
- type steel

Adapted to any building type. Aluminium can be painted in every shade and colour:

- RAL (pastel finishes)
- Speckled (dotted finishes)

For those who have particular tastes or to fit the architectural exterior style, aluminium can be painted (sublimated) in various design solutions:

- marble effect
- wood effect
- copper effect
- rust effect

Calabria

Sidertre S.r.l.
Via Carfellà, 14
88040 Settingiano - CZ
T. +39 0961 998281
calabria@alsistem.com

Campania, Basilicata

Meral S.p.a.
V. Scavate Case Rosse (Z.I.)
84131 Salerno - SA
T. +39 089 301155
campania@alsistem.com

Lazio

Aluroma S.r.l.
Via dell'Omo, 161
00155 Roma
T. +39 06 2283184
lazio@alsistem.com

Lombardia, Triveneto

Alca S.r.l.
Via Copernico, 2
25020 Poncarale - BS
T. +39 030 2681141
lombardia@alsistem.com

Piemonte, Liguria, Valle d'Aosta

Fresia Alluminio S.p.a.
Via Venezia, 35
10088 Volpiano - TO
T. +39 011 2250211
piemonte@alsistem.com

Deposito Liguria:

Via Bertola, 11
17047 Vado Ligure - SV
T. +39 019.882783

Puglia

Sael S.r.l.
Via Mare, snc
72027 San Pietro Vernotico-BR
T. +39 0831 653598
puglia@alsistem.com

Sardegna

Marini S.p.a.
V.le Monastir, Km10.300
09028 Sestu - CA
T. +39 070 22331
sardegna@alsistem.com

Sicilia

Edilsider S.p.a.
Via B. Croce, 26
91011 Alcamo - TP
T. +39 0924 21588
sicilia@alsistem.com

Deposito Sicilia orientale:
Contrada Pirritino Pantano,
Zona Industriale ovest
Piano Tavola
95032 Belpasso - CT

Toscana

Ferroedilizia S.r.l.
Via Aurelia Nord, 233
58100 Grosseto - GR
T. +39 0564 456300
toscana@alsistem.com

alsistem.com

Emilia Romagna

ALSistem Emilia Romagna
Via Delle Querce, 15/21
60027 Osimo - AN
T. +39 071 7132362
emiliaromagna@alsistem.com

P.R.C, Hong kong, Taiwan, Macao

Alsistem HK
room711,7/f
Ninggu Commercial Building
no.7940 Humin road,
Minhang district
201102 Shanghai